



www.arsulama.com



Sulama Sistemleri IRRIGATION SYSTEMS

2023-2024

ÜRÜN KATALOĞU

Product Catalogue



www.driptime.com.tr

İÇİNDEKİLER

Table of Contents

1.00 /	Damlama Sulama Sistemleri / Drip Irrigation Systems	- 3
1.01 /	Mini Vanalar / <i>Mini Valves</i>	- 4
1.02 /	Deliciler / <i>Perforation Tool</i>	- 8
1.03 /	Damlama Ek Parçalar / <i>Drip Irrigation Fittings</i>	- 9
1.04 /	Damlatıcı ve Contalar / <i>Drippers and Gaskets</i>	- 13
1.05 /	Yuvarlak Damlama Sulama Borusu / <i>Round Drip Irrigation Pipe</i>	- 15
1.06 /	Yassı Damlama Sulama Borusu / <i>Flat Drip Irrigation Pipe</i>	- 17
2.00 /	Yağmurlama Sulama Sistemleri / Sprinkler Irrigation Systems	- 18
2.01 /	Borular ve Ek Parçalar / <i>Sprinklers</i>	- 19
2.02 /	Sprinkler / <i>Sprinklers</i>	- 21
3.00 /	Mikro Sprink Sistemleri / Micro Sprinkler Systems	- 22
3.01 /	Spagetti Boru ve Ek Parçaları / <i>Spaghetti Pipe and Fittings</i>	- 23
4.00 /	Filtre Sistemleri / Filtration Systems	- 25
4.01 /	Galvaniz Ek Parçaları / <i>Galvanized Fittings</i>	- 26
4.02 /	Motopomp Bağlantı Parçaları / <i>Motopomp Connection Parts</i>	- 28
4.03 /	Plastik Filtreler / <i>Plastic Filters</i>	- 29
4.04 /	Metal Filtreler / <i>Metal Filters</i>	- 30



Konuşulan Kalite
the spoken quality



Biz Kimiz? WHO WE ARE?

HAKKIMIZDA
About Us

AR Tarımsal Sulama Şirketi 2008 yılından bu yana vana, bağlantı elemanları, sprinkler ve filtrasyon ekipmanları üretmektedir.

Driptime®, AR Tarımsal Sulama Şirketinin tescilli bir markasıdır.

Sektöründe her yıl üretim kapasitesini geliştiren firmalar arasında yer alan firmamız ürettiği ürünlerle ülkemizde ve dünyada sulama sistemlerinin kullanımı, yaygınlaştırılması ve geliştirilmesi konusunda çalışmaktadır.

Firmamız ürünlerini tüm özverisi ile çiftçilerimize ulaştırırken, birçok ülkedeki ortakları, distribütörleri ve temsilcileri aracılığıyla dünya pazarındaki itibarını her geçen gün artırmaktadır.

AR Agricultural Irrigation Company has been producing valves, fittings, sprinkler and filtration equipment since 2008.

Driptime® is a brand of AR Agricultural Irrigation Company.

Our company, which is among the companies that develops its production capacity every year in its sector, works on the use, dissemination and development of irrigation systems in our country and in the world with the products it produces.

While our company delivers its products to our farmers with all its devotion, it increases its reputation day by day in the world market through its partners, distributors and representatives in many countries.





Misyonumuz & Vizyonumuz Our Mission & Vision

Akreditasyonlar Accreditations



Ürün çeşitliliğini her geçen gün artıran firmamız, sulama sektörü ile ilgili yeni ürünler üretme ve mevcut ürünleri iyileştirme çalışmaları sonucunda birçok faydalı ürünün sektöre dahil olmasına öncülük etmiştir.

Our company, which increases its product range day by day, has pioneered the inclusion of many useful products in the sector as a result of its efforts to produce new products related to the irrigation sector and to improve existing products.

Vizyonumuz; Kalite ilkeleri doğrultusunda oluşturduğumuz yönetim ve geliştirme stratejilerimiz ile birlikte ürettiğimiz ürünlerle dünya çapındaki müşterilerin ilk tercihi olmaktır.

Our vision; To be the first choice of customers worldwide with the products we produce together with our management and development strategies that we have created in accordance with the principles of quality.

Misyonumuz; Çalışanları, müşterileri, ürün ve hizmet sağlayıcıları ile profesyonelce çalışmak, müşteri taleplerini %100 memnuniyetle karşılamak ve sürekliliğini sağlamaktır.

Our mission; To work professionally with its employees, customers, product and service providers, to meet customer demands with 100% satisfaction and to ensure their continuity.





MINİ VANALAR

Mini Valves

Damlama Sulama Sistemleri
Drip Irrigation Systems

**Konuşulan
Kalite**

the spoken quality

www.arsulama.com



kod code	ölçüler mm dimension mm	koli adet package pcs
DTR 7001	16 x 16	500
DTR 7002	20 x 20	400
DTR 7003	20 x 16	400



Kurtağız Mini Vana
Barbed Mini Valve

kod code	ölçüler mm dimension mm	koli adet package pcs
DTR 7004	16 x 16	500
DTR 7005	20 x 20	400



Conta Çıkış Kurtağız Mini Vana
Offtake Barbed Mini Valve

kod code	ölçüler mm dimension mm	koli adet package pcs
DTR 7006	1/2" x 16	500
DTR 7007	3/4" x 16	500
DTR 7008	1/2" x 20	400
DTR 7009	3/4" x 20	400

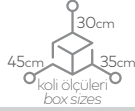

Kurtağız Erkek Dişli Mini Vana
Barbed Male Mini Valve

kod code	ölçüler mm dimension mm	koli adet package pcs
DTR 7010	16 x 17	400
DTR 7011	20 x 17	350

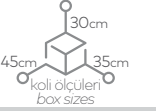

Conta Çıkış Vidalı Mini Vana
Offtake Mini Valve with Nut

kod code	ölçüler mm dimension mm	koli adet package pcs
DTR 7012	16 x 17	400
DTR 7013	20 x 17	400

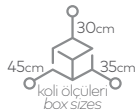

Kurtağız Vidalı Mini Vana
Barbed Mini Valve with Nut

kod code	ölçüler mm dimension mm	koli adet package pcs
DTR 7014	1/2" x 17	400
DTR 7015	3/4" x 17	400

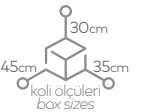

Vidalı Erkek Dişli Mini Vana
With Nut Male Mini Valve

kod code	ölçüler mm dimension mm	koli adet package pcs
DTR 7016	16 x 17	400
DTR 7017	20 x 17	400
DTR 7025	20 x 22	300

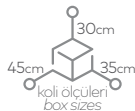
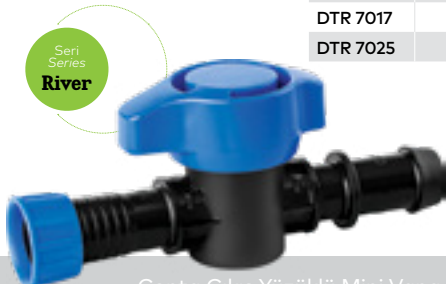

Conta Çıkış Yüzlü Mini Vana
Offtake Mini Valve with Ring

kod code	ölçüler mm dimension mm	koli adet package pcs
DTR 7018	16 x 17	400
DTR 7019	20 x 17	400
DTR 7026	20 x 22	300



Yüzlü Kurtağız Mini Vana
Barbed Mini Valve with Ring

kod code	ölçüler mm dimension mm	koli adet package pcs
DTR 7020	1/2" x 17	400
DTR 7021	3/4" x 17	400
DTR 7027	1/2" x 22	300
DTR 7028	3/4" x 22	300



Yüzüklü Erkek Dişli Mini Vana
With Ring Male Mini Valve



kod code	ölçüler mm dimension mm	koli adet package pcs
DTR 7022	17 x 17	400
DTR 7023	22 x 22	300



Yüzüklü Mini Vana
Mini Valve with Ring

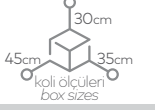

kod code	ölçüler mm dimension mm	koli adet package pcs
DTR 7024	17 x 17	300



Vidalı Mini Vana
Mini Valve with Nut

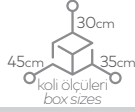

kod code	ölçüler mm dimension mm	paket adet package pcs
DTR 7033	12 x 17	300



Contasız Bağlantı Yüzüklü Mini Vana
Without Gasket Connection Mini Valve with Ring

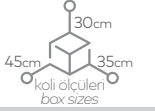

kod code	ölçüler mm dimension mm	paket adet package pcs
DTR 7034	12 x 16	350
DTR 7035	12 x 20	300



Contasız Bağlantı Kurtağuz Mini Vana
Without Gasket Connection Barbed Mini Valve

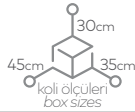

kod code	ölçüler mm dimension mm	paket adet package pcs
DTR 7032	12 x 17	300



Contasız Bağlantı Vidalı Mini Vana
Without Gasket Connection Mini Valve with Nut

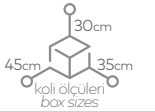

kod code	ölçüler mm dimension mm	koli adet package pcs
DTR 7031	16	300



Kurtağuz LayFlat Mini Vana
LayFlat Barbed Mini Valve



kod code	ölçüler mm dimension mm	koli adet package pcs
DTR 7030	17	300



Yüzüklü LayFlat Mini Vana
LayFlat with Ring Mini Valve

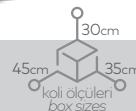

kod code	ölçüler mm dimension mm	koli adet package pcs
DTR 7029	17	300



Somunlu LayFlat Mini Vana
LayFlat with Nut Mini Valve



kod code	ölçüler mm dimension mm	koli adet package pcs
DTGOLD 3001	16 x 16	500
DTGOLD 3002	20 x 20	400
DTGOLD 3003	20 x 16	400

Seri
Series
Gold



Kurtağız Mini Vana
Barbed Mini Valve

kod code	ölçüler mm dimension mm	koli adet package pcs
DTGOLD 3004	16 x 16	500
DTGOLD 3005	20 x 20	400

Seri
Series
Gold



Conta Çıkış Kurtağız Mini Vana
Offtake Barbed Mini Valve

kod code	ölçüler mm dimension mm	koli adet package pcs
DTGOLD 3006	1/2" x 16	500
DTGOLD 3007	3/4" x 16	500
DTGOLD 3008	1/2" x 20	400
DTGOLD 3009	3/4" x 20	400

Seri
Series
Gold

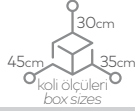

Kurtağız Erkek Dişli Mini Vana
Barbed Male Mini Valve

kod code	ölçüler mm dimension mm	koli adet package pcs
DTGOLD 3010	16 x 17	400
DTGOLD 3011	20 x 17	350

Seri
Series
Gold

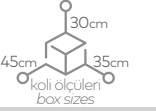

Conta Çıkış Vidalı Mini Vana
Offtake Mini Valve with Nut

kod code	ölçüler mm dimension mm	koli adet package pcs
DTGOLD 3012	16 x 17	400
DTGOLD 3013	20 x 17	400

Seri
Series
Gold

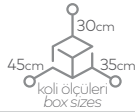

Kurtağız Vidalı Mini Vana
Barbed Mini Valve with Nut

kod code	ölçüler mm dimension mm	koli adet package pcs
DTGOLD 3014	1/2" x 17	400
DTGOLD 3015	3/4" x 17	400

Seri
Series
Gold

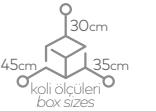

Vidalı Erkek Dişli Mini Vana
With Nut Male Mini Valve

kod code	ölçüler mm dimension mm	koli adet package pcs
DTGOLD 3016	16 x 17	400
DTGOLD 3017	20 x 17	400
DTGOLD 3025	20 x 22	300

Seri
Series
Gold



Conta Çıkış Yüzüklü Mini Vana
Offtake Mini Valve with Ring

kod code	ölçüler mm dimension mm	koli adet package pcs
DTGOLD 3018	16 x 17	400
DTGOLD 3019	20 x 17	400
DTGOLD 3026	20 x 22	300

Seri
Series
Gold

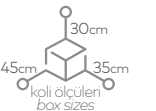

Yüzüklü Kurtağız Mini Vana
Barbed Mini Valve with Ring

kod code	ölçüler mm dimension mm	koli adet package pcs
DTGOLD 3020	1/2" x 17	400
DTGOLD 3021	3/4" x 17	400
DTGOLD 7027	1/2" x 22	300
DTGOLD 7028	3/4" x 22	300

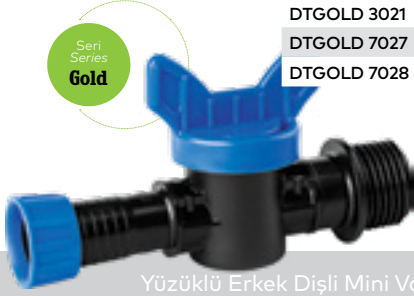

Yüzüklü Erkek Dişli Mini Vana
With Ring Male Mini Valve

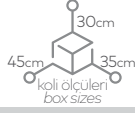

kod code	ölçüler mm dimension mm	koli adet package pcs
DTGOLD 3022	17 x 17	400
DTGOLD 3023	22 x 22	300



Yüzüklü Mini Vana
Mini Valve with Ring

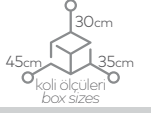

kod code	ölçüler mm dimension mm	koli adet package pcs
DTGOLD 3024	17 x 17	300



Vidalı Mini Vana
Mini Valve with Nut

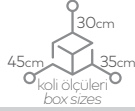

kod code	ölçüler mm dimension mm	paket adet package pcs
DTGOLD 3033	12 x 17	300



Contasız Bağlantı Yüzüklü Mini Vana
Without Gasket Connection Mini Valve with Ring

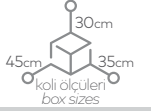

kod code	ölçüler mm dimension mm	paket adet package pcs
DTGOLD 3034	12 x 16	350
DTGOLD 3035	12 x 20	300



Contasız Bağlantı Kurtağız Mini Vana
Without Gasket Connection Barbed Mini Valve

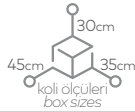

kod code	ölçüler mm dimension mm	paket adet package pcs
DTGOLD 3032	12 x 17	300



Contasız Bağlantı Vidalı Mini Vana
Without Gasket Connection Mini Valve with Nut

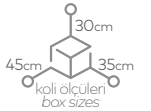

kod code	ölçüler mm dimension mm	koli adet package pcs
DTGOLD 3031	16	300



Kurtağız LayFlat Mini Vana
LayFlat Barbed Mini Valve



kod code	ölçüler mm dimension mm	koli adet package pcs
DTGOLD 3030	17	300



Yüzüklü LayFlat Mini Vana
LayFlat with Ring Mini Valve



kod code	ölçüler mm dimension mm	koli adet package pcs
DTGOLD 3029	17	300



Somunlu LayFlat Mini Vana
LayFlat with Nut Mini Valve



kod code	ölçüler mm dimension mm	koli adet package pcs
DTB 6007	25 x 25	250
DTB 6008	25 x 20	250
DTB 6009	25 x 16	250

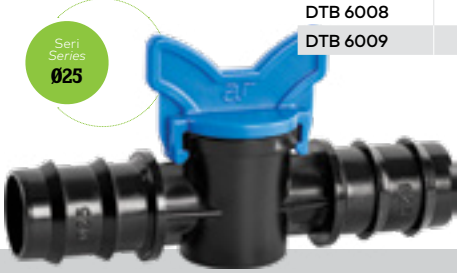

Kurtagzi Mini Vana
Barbed Mini Valve



kod code	ölçüler mm dimension mm	koli adet package pcs
DTB 6026	25 x 1/2"	250
DTB 6027	25 x 3/4"	250

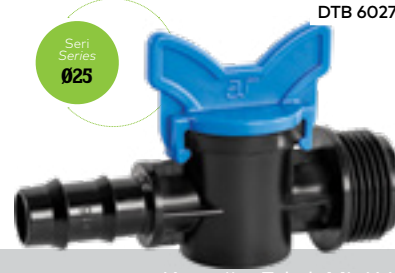

Kurtagiz Erkek Mini Vana
Offtake Barbed Mini Valve



kod code	ölçüler mm dimension mm	koli adet package pcs
DTT 6601	3	250
DTT 6602	8	250



Sustali Delici
Dripper Perforation Tool - Punch

kod code	ölçüler mm dimension mm	koli adet package pcs
DTT 6603	16	250
DTT 6604	20	250
DTT 6605	25	250
DTT 6606	32	250



El ile Delme
Manual Main Pipe Perforation Tool

kod code	ölçüler mm dimension mm	koli adet package pcs
DTT 6607	16	250
DTT 6608	20	250
DTT 6609	25	250
DTT 6610	32	250



Matkap Ucu
Main Pipe Perforation Tool (for Drill)



kod code	ölçüler mm dimension mm	paket adet package pcs
DTBF 4001	17 x 17	750



Vidalı Ekleme Nipel
Nipple with Nut

kod code	ölçüler mm dimension mm	paket adet package pcs
DTBF 4002	16 x 17	1.000



Vidalı Çıkış Nipel
Offtake Nipple with Nut

kod code	ölçüler mm dimension mm	paket adet package pcs
DTBF 4003	16 x 17	1.000



Kurtağız Vidalı Çıkış Nipel
Barbed Offtake Nipple with Nut

kod code	ölçüler mm dimension mm	paket adet package pcs
DTBF 4004	17 x 17	1.000
DTBF 4005	22 x 22	500
DTBF 4006	25 x 25	500



Conta Çıkış Vidalı Mini Vana
Nipple with Ring

kod code	ölçüler mm dimension mm	paket adet package pcs
DTBF 4007	16 x 17	1.500
DTBF 4008	20 x 22	750
DTBF 4009	20 x 25	500



Yüzüklü Çıkış Nipel
Offtake Nipple with Ring

kod code	ölçüler mm dimension mm	paket adet package pcs
DTBF 4010	16 x 17	1.500



Kurtağız Yüzüklü Çıkış Nipel
Barbed Offtake Nipple with Ring

kod code	ölçüler mm dimension mm	paket adet package pcs
DTBF 4011	16 x 16	2.000
DTBF 4012	20 x 20	1.500



Kurtağız Çıkış Nipel
Offtake Nipple

kod code	ölçüler mm dimension mm	paket adet package pcs
DTBF 4013	16 x 16	1.750
DTBF 4014	20 x 20	1.000
DTBF 4015	25 x 25	500



Kurtağız Ekleme Nipel
Barbed Nipple



kod code	ölçüler mm dimension mm	paket adet package pcs
DTBF 4029	20 x 16	1.250
DTBF 4030	25 x 16	750
DTBF 4031	25 x 20	500

Kurtuluş Redüksiyon Ekleme
Barbed Nipple Reduction



kod code	ölçüler mm dimension mm	paket adet package pcs
DTBF 4036	16 x 16	2.000

Kurtuluş Çıkış Nipeli V Model
Offtake Nipple V Model



kod code	ölçüler mm dimension mm	paket adet package pcs
DTBF 4018	16 x 7 x 16	1.000
DTBF 4019	16 x 16 x 16	1.000
DTBF 4020	20 x 16 x 20	750
DTBF 4021	20 x 20 x 20	700
DTBF 4032	16 x 20 x 16	1.000
DTBF 4033	25 x 16 x 25	400
DTBF 4034	25 x 20 x 25	400
DTBF 4035	25 x 25 x 25	400

Kurtuluş TE
Barbed Tee



kod code	ölçüler mm dimension mm	paket adet package pcs
DTBF 4022	16 x 16	1.500
DTBF 4023	20 x 20	1.000

Kurtuluş Dirsek
Barbed Elbow



Gözlük Kör Tapa
Glasses End Cap

kod code	ölçüler mm dimension mm	paket adet package pcs
DTBF 4024	16	2.000
DTBF 4025	20	1.500



Kurtuluş Y
Barbed Y

kod code	ölçüler mm dimension mm	paket adet package pcs
DTBF 4026	16 x 16 x 16	750
DTBF 4027	20 x 16 x 16	750
DTBF 4028	20 x 20 x 20	750



Kör Tapa
Barbed End Cap

kod code	ölçüler mm dimension mm	paket adet package pcs
DTBF 4016	16	2.000
DTBF 4017	20	1.500
DTBF 4067	16 qb	2.000



Yüzlü Kör Tapa
End Cap with Ring

kod code	ölçüler mm dimension mm	paket adet package pcs
DTBF 4037	17	1.000
DTBF 4038	22	750

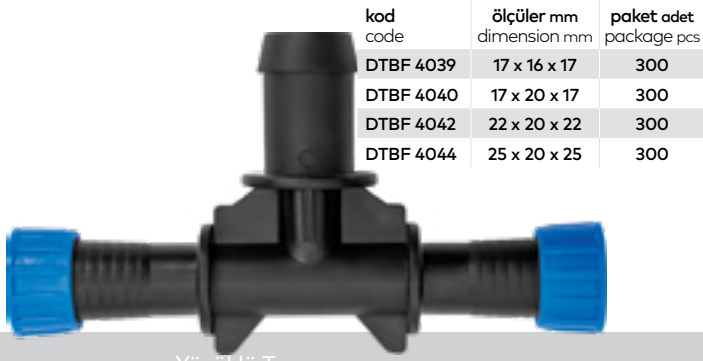

Yüzüklü Te
Tee with Ring

kod code	ölçüler mm dimension mm	paket adet package pcs
DTBF 4039	17 x 16 x 17	300
DTBF 4040	17 x 20 x 17	300
DTBF 4042	22 x 20 x 22	300
DTBF 4044	25 x 20 x 25	300



Somunlu Te
Tee with Nut

kod code	ölçüler mm dimension mm	paket adet package pcs
DTBF 4046	17 x 17 x 17	300

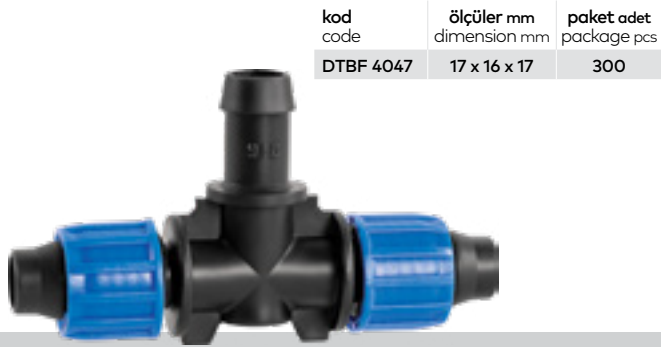

Somunlu Te
Tee with Nut

kod code	ölçüler mm dimension mm	paket adet package pcs
DTBF 4047	17 x 16 x 17	300

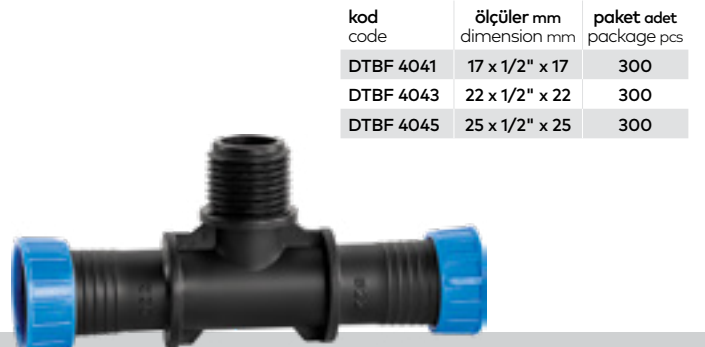

Yüzüklü Erkek Te
Male Tee with Ring

kod code	ölçüler mm dimension mm	paket adet package pcs
DTBF 4041	17 x 1/2" x 17	300
DTBF 4043	22 x 1/2" x 22	300
DTBF 4045	25 x 1/2" x 25	300



Contasız Kurtağız Çıkış Nipelini
Barbed Offtake Nipple (without Gasket)

kod code	ölçüler mm dimension mm	paket adet package pcs
DTBF 4048	12x16	1.000

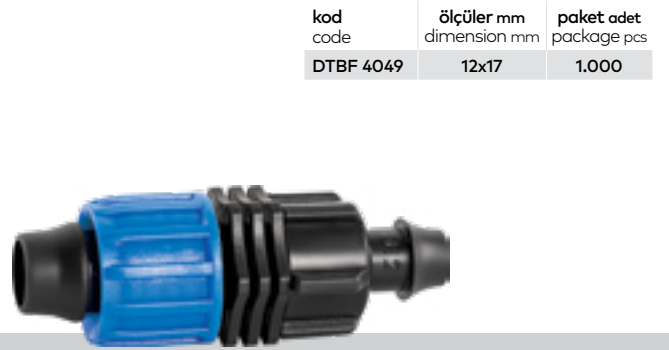

Contasız Vidalı Çıkış Nipelini
Offtake Nipple with Nut (without Gasket)

kod code	ölçüler mm dimension mm	paket adet package pcs
DTBF 4049	12x17	1.000



Dört Kurtağız Ekleme Nipelini
Barbed Nipple - 4 Barb

kod code	ölçüler mm dimension mm	paket adet package pcs
DTBF4068	16 x 16	1.750





kod code	ölçüler mm dimension mm	paket adet package pcs
DTBF 4055	3/4" x 1/2"	900
DTBF 4056	1" x 1/2"	600
DTBF 4057	1" x 3/4"	600
DTBF 4058	1 1/4" x 3/4"	400
DTBF 4059	1 1/4" x 1"	400
DTBF 4060	1 1/2" x 1"	300
DTBF 4061	1 1/2" x 1 1/4"	200

Siyah Plastik Nipel Redüksiyon
Black Plastic Nipple Reducer



kod code	ölçüler mm dimension mm	paket adet package pcs
DTBF 4050	1/2"	800
DTBF 4051	3/4"	600
DTBF 4052	1"	400
DTBF 4053	1 1/4"	250
DTBF 4054	1 1/2"	150

Siyah Plastik Nipel
Black Plastic Nipple

kod code	uzunluk cm length cm	paket adet package pcs
DTBF 4069	17	250



Damlama Borusu Sabitleme Kaziğı - Kısa
Drip Irrigation Pipe Stabilizing Stake - Short

kod code	uzunluk cm length cm	paket adet package pcs
DTBF 4070	25	250



Damlama Borusu Sabitleme Kaziğı - Uzun
Drip Irrigation Pipe Stabilizing Stake - Long



kod code	debi lt/s flow rate lt/h	paket adet package pcs
DTD 9901	0 - 150	2.000



Siyah Damlatıcı
Black Dripper



kod code	debi lt/s flow rate lt/h	paket adet package pcs
DTD 9902	0 - 70	4.000



Kırmızı Damlatıcı
Red Dripper



kod code	debi lt/s flow rate lt/h	paket adet package pcs
DTD 9903	0 - 100	2.500



Yeşil Damlatıcı
Green Dripper



kod code	debi lt/s flow rate lt/h	paket adet package pcs
DTD 9904	2	2.500
DTD 9905	4	2.500
DTD 9906	8	2.500
DTD 9907	16	2.500



Basınç Ayarlı Damlatıcı
Pressure Compensating Dripper



kod code	ölçüler mm dimension mm	paket adet package pcs
DTG 8801	16	2.500
DTG 8802	20	2.000



Düz Conta
Flat Gasket

kod code	ölçüler mm dimension mm	paket adet package pcs
DTG 8803	16	3.000
DTG 8804	20	2.500
DTG 8805	25	1.500



Kanallı Conta
Barbed Grommet Gasket

kod code	ölçüler mm dimension mm	paket adet package pcs
DTG 8806	16	3.000
DTG 8807	20	2.500



Conta Kör Tapa
End Cap Gasket

kod code	ölçüler mm dimension mm	paket adet package pcs
DTG 8808	16	3.000



Kanallı Conta V Model
Barbed Grommet Gasket V Model

Damlama Borulari Drip Irrigation Pipe

Damlama Sulama Sistemleri
Drip Irrigation Systems



Konuşulan Kalite

the spoken quality

www.arsulama.com



kod code	çap Ø diameter Ø	et kalınlığı mm wall thickness mm	debi lt/s flow rate lt/h	damla aralığı cm dripping distance cm	rulo uzunluğu m roll length m
DTP 160920	16 mm	0,9		20	400
DTP 160925	16 mm	0,9		25	400
DTP 160933	16 mm	0,9	2 - 4 - 8 - 16	33	400
DTP 160940	16 mm	0,9		40	400
DTP 160950	16 mm	0,9		50	400
DTP 161020	16 mm	1,0		20	400
DTP 161025	16 mm	1,0		25	400
DTP 161033	16 mm	1,0	2 - 4 - 8 - 16	33	400
DTP 161040	16 mm	1,0		40	400
DTP 161050	16 mm	1,0		50	400
DTP 161120	16 mm	1,1		20	400
DTP 161125	16 mm	1,1		25	400
DTP 161133	16 mm	1,1	2 - 4 - 8 - 16	33	400
DTP 161140	16 mm	1,1		40	400
DTP 161150	16 mm	1,1		50	400
DTP 201020	20 mm	1,0		20	300
DTP 201025	20 mm	1,0		25	300
DTP 201033	20 mm	1,0	2 - 4 - 8 - 16	33	300
DTP 201040	20 mm	1,0		40	300
DTP 201050	20 mm	1,0		50	300
DTP 201120	20 mm	1,1		20	300
DTP 201125	20 mm	1,1		25	300
DTP 201133	20 mm	1,1	2 - 4 - 8 - 16	33	300
DTP 201140	20 mm	1,1		40	300
DTP 201150	20 mm	1,1		50	300
DTP 201220	20 mm	1,2		20	300
DTP 201225	20 mm	1,2		25	300
DTP 201233	20 mm	1,2	2 - 4 - 8 - 16	33	300
DTP 201240	20 mm	1,2		40	300
DTP 201250	20 mm	1,2		50	300



Yuvarlak Damlama Sulama Borusu (Delikli)
Drip Irrigation Pipe (witht Dripper)



Standart Tir
Standart Truck
480 rulo/rolls



20' DC Konteyner
20' DC Container
186 rulo/rolls



40' HC Konteyner
40' HC Container
416 rulo/rolls



Yuvarlak Damlama Sulama Borusu (Düz)
Drip Irrigation Pipe (without Dripper)



Standart Tir
Standart Truck
480 rulo/rolls



20' DC Konteyner
20' DC Container
186 rulo/rolls



40' HC Konteyner
40' HC Container
416 rulo/rolls

kod code	çap Ø diameter Ø	et kalınlığı mm wall thickness mm	rulo uzunluğu m roll length m
DTPD 1609	16 mm	0,9	400
DTPD 1610	16 mm	1,0	400
DTPD 1611	16 mm	1,1	400
DTPD 2010	20 mm	1,0	300
DTPD 2011	20 mm	1,1	300
DTPD 2012	20 mm	1,2	300

Yuvarlak Damlama Sulama Borusu Basınç - Debi İlişkisi Grafiği Round Drip Irrigation Pipe Pressure - Flow Relationship Graph

nominal debi flow rate	basınç bar pressure bar												
LPH	0,6	0,8	1	1,2	1,4	1,6	1,8	2	2,2	2,4	2,6	2,8	3
2	1,62	1,86	2,08	2,27	2,45	2,62	2,77	2,92	3,06	3,19	3,32	3,44	3,56
4	3,12	3,59	4,01	4,38	4,73	5,05	5,35	5,63	5,9	6,16	6,4	6,64	6,87

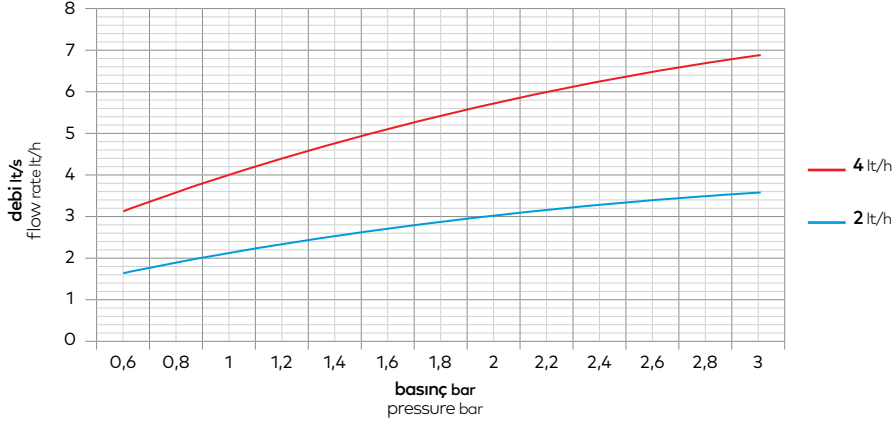

Ø 16 mm Yuvarlak Damla Sulama Borularımızın 2,0 lt/s ve 4,0 lt/s Debili Damlatıcılarına ait Basınç - Debi ilişkisi grafiğidir.
The pressure - Flow rate relations belong to the 2,0 lt/h and 4,0 lt/h drippers of our Ø 16 mm round Drip Irrigation pipes.

Yuvarlak Damlama Sulama Borusu Maksimum Çalışma Uzunluğu Grafiği Round Drip Line Maximum Working Length Chart

nominal debi flow rate	damlatıcı aralığı cm dripper distance cm									
LPH	20	25	30	33	40	50	60	75	100	120
2	54	66	80	85	98	116	130	152	190	209
4	42	44	54	57	65	75	88	101	120	128

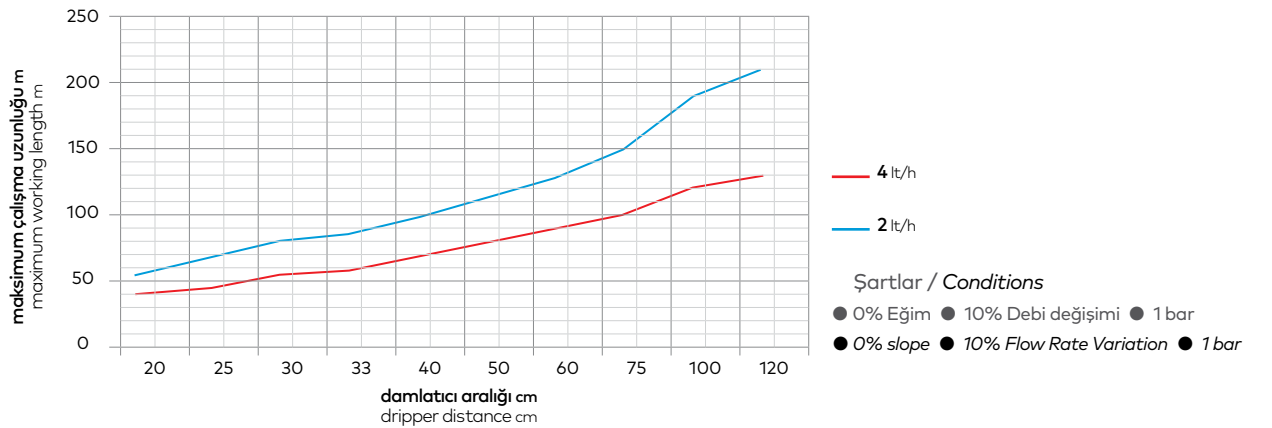

2,0 lt/s ve 4,0 lt/s Debili Ø 16 mm Yuvarlak Damla Sulama Borularımızın farklı çalışma koşullarında eşit su dağılımını sağlayacak en uygun lateral uzunlukları (lateral sonu basıncı: 1 bar)

The optimum lateral lengths to provide equal water distribution at various operation conditions of our Ø 16 mm round Drip Irrigation pipes (with 2,0 lt/h and 4,0 lt/h drippers) (lateral end pressure: 1 bar)

Yassı Damlama Sulama Borusu

Flat Drip Irrigation Pipe

Damlama Sulama Sistemleri
Drip Irrigation Systems



kod code	mil mil	et kalınlığı mm wall thickness mm	ıç ap � id �	dıř ap � od �	rulo uzunluđu m roll length m	1 palettteki rulo sayısı roll quantity per pallet	maks. alıřma basıncı max. working pressure
DTEF 1606	6	0,15	16,1	16,4	2500	16	1
DTEF 1608	8	0,2	16,1	16,5	2300	16	1,2
DTEF 1610	10	0,25	16,1	16,6	2100	16	1,4
DTEF 1612	12	0,3	16,1	16,7	1900	16	1,6



Standart Tir
Standart Truck

828 rulo/rolls



20' DC Konteyner
20' DC Container

320 rulo/rolls



40' HC Konteyner
40' HC Container

756 rulo/rolls

17 mm Damlama Sulama Borusu
17 mm Drip Irrigation Pipe



kod code	mil mil	et kalınlığı mm wall thickness mm	ıç ap � id �	dıř ap � od �	rulo uzunluđu m roll length m	1 palettteki rulo sayısı roll quantity per pallet	maks. alıřma basıncı max. working pressure
DTEF 2208	8	0,2	22,2	22,6	1500	16	1,1
DTEF 2210	10	0,25	22,2	22,7	1300	16	1,4
DTEF 2212	12	0,3	22,2	22,8	1200	16	1,6



Standart Tir
Standart Truck

828 rulo/rolls



20' DC Konteyner
20' DC Container

320 rulo/rolls



40' HC Konteyner
40' HC Container

756 rulo/rolls

22 mm Damlama Sulama Borusu
22 mm Drip Irrigation Pipe



kod code	mil mil	et kalınlığı mm wall thickness mm	ıç ap � id �	dıř ap � od �	rulo uzunluđu m roll length m	1 palettteki rulo sayısı roll quantity per pallet	maks. alıřma basıncı max. working pressure
DTEF 2508	8	0,2	25,2	25,6	1300	16	1
DTEF 2510	10	0,25	25,2	25,7	1100	16	1,3
DTEF 2512	12	0,3	25,2	25,8	1000	16	1,4



Standart Tir
Standart Truck

828 rulo/rolls



20' DC Konteyner
20' DC Container

320 rulo/rolls



40' HC Konteyner
40' HC Container

756 rulo/rolls

25 mm Damlama Sulama Borusu
25 mm Drip Irrigation Pipe



BORULAR ve EK PARÇALAR

Pipes and Fittings

Yağmurlama Sulama
Sprinkler Irrigation

Sprinkler Sprinklers



Konuşulan Kalite

the spoken quality

www.arsulama.com

Not: Bütün yağmurlama boru ve ek parçalarında plastik mandal alternatifimiz mevcuttur.

Note: We have a plastic latch alternative for all sprinkler pipes and fittings.



kod code	ölçüler mm dimension mm
DTSS 6009	50
DTSS 6010	63
DTSS 6011	75
DTSS 6012	90
DTSS 6013	110

*
*

Abot
Hydrant Latch Type



kod code	ölçüler mm dimension mm
DTSS 6001	50
DTSS 6002	63
DTSS 6003	75
DTSS 6004	90
DTSS 6005	110
DTSS 6006	125
DTSS 6007	140
DTSS 6008	160

Mandallı Boru
Pipe Latch Type



kod code	ölçüler mm dimension mm	koli adet package pcs
DTSS 6022	50	100
DTSS 6023	63	100
DTSS 6024	75	100
DTSS 6025	90	70
DTSS 6026	110	50
DTSS 6027	125	30
DTSS 6028	140	20
DTSS 6029	160	15

Erkek Kör Tapa
Male End Cap



kod code	ölçüler mm dimension mm	koli adet package pcs
DTSS 6014	50	250
DTSS 6015	63	200
DTSS 6016	75	100
DTSS 6017	90	70
DTSS 6018	110	50
DTSS 6019	125	30
DTSS 6020	140	20
DTSS 6021	160	15

Erkek Başlık
Male Head



kod code	ölçüler mm dimension mm	koli adet package pcs
DTSS 6038	50	100
DTSS 6039	63	100
DTSS 6040	75	100
DTSS 6041	90	70
DTSS 6042	110	50
DTSS 6043	125	30
DTSS 6044	140	20
DTSS 6045	160	15

Dişi Kör Tapa
Female End Cap



kod code	ölçüler mm dimension mm	koli adet package pcs
DTSS 6030	50	250
DTSS 6031	63	200
DTSS 6032	75	100
DTSS 6033	90	70
DTSS 6034	110	50
DTSS 6035	125	30
DTSS 6036	140	20
DTSS 6037	160	15

Dişi Başlık
Female Head



Redüksiyon
Reduction

kod code	ölçüler mm dimension mm	koli adet package pcs
DTSS 6046	63 x 50	50
DTSS 6047	75 x 50	30
DTSS 6048	75 x 63	25
DTSS 6049	90 x 50	30
DTSS 6050	90 x 63	30
DTSS 6051	90 x 75	30
DTSS 6052	110 x 75	20
DTSS 6053	110 x 90	20
DTSS 6054	125 x 75	15

kod code	ölçüler mm dimension mm	koli adet package pcs
DTSS 6055	125 x 90	12
DTSS 6056	125 x 110	12
DTSS 6057	140 x 90	11
DTSS 6058	140 x 110	10
DTSS 6059	140 x 125	10
DTSS 6060	160 x 110	10
DTSS 6061	160 x 125	9
DTSS 6062	160 x 140	7



Te
Tee

kod code	ölçüler mm dimension mm
DTSS 6095	50 x 50
DTSS 6096	63 x 50
DTSS 6097	63 x 63
DTSS 6098	75 x 50
DTSS 6099	75 x 63
DTSS 6100	75 x 75
DTSS 6101	90 x 50
DTSS 6102	90 x 63
DTSS 6103	90 x 75
DTSS 6104	90 x 90
DTSS 6105	110 x 50

kod code	ölçüler mm dimension mm
DTSS 6106	110 x 63
DTSS 6107	110 x 75
DTSS 6108	110 x 90
DTSS 6109	110 x 110
DTSS 6110	125 x 50
DTSS 6111	125 x 63
DTSS 6112	125 x 75
DTSS 6113	125 x 90
DTSS 6114	125 x 110
DTSS 6115	125 x 125
DTSS 6116	140 x 75

kod code	ölçüler mm dimension mm
DTSS 6117	140 x 90
DTSS 6118	140 x 110
DTSS 6119	140 x 125
DTSS 6120	140 x 140
DTSS 6121	160 x 75
DTSS 6122	160 x 90
DTSS 6123	160 x 110
DTSS 6124	160 x 125
DTSS 6125	160 x 140
DTSS 6126	160 x 160



İstavroz
Cross

kod code	ölçüler mm dimension mm
DTSS 6063	50 x 50
DTSS 6064	63 x 50
DTSS 6065	63 x 63
DTSS 6066	75 x 50
DTSS 6067	75 x 63
DTSS 6068	75 x 75
DTSS 6069	90 x 50
DTSS 6070	96 x 63
DTSS 6071	90 x 75
DTSS 6072	90 x 90
DTSS 6073	110 x 50

kod code	ölçüler mm dimension mm
DTSS 6074	110 x 63
DTSS 6075	110 x 75
DTSS 6076	110 x 90
DTSS 6077	110 x 110
DTSS 6078	125 x 50
DTSS 6079	125 x 63
DTSS 6080	125 x 75
DTSS 6081	125 x 90
DTSS 6082	125 x 110
DTSS 6083	125 x 125
DTSS 6084	140 x 75

kod code	ölçüler mm dimension mm
DTSS 6085	140 x 90
DTSS 6086	140 x 110
DTSS 6087	140 x 125
DTSS 6088	140 x 140
DTSS 6089	160 x 75
DTSS 6090	160 x 90
DTSS 6091	160 x 110
DTSS 6092	160 x 125
DTSS 6093	160 x 140
DTSS 6094	160 x 160



DİRsek
Elbow

kod code	ölçüler mm dimension mm
DTSS 6127	50
DTSS 6128	63
DTSS 6129	75
DTSS 6130	90
DTSS 6131	110
DTSS 6132	125
DTSS 6133	140
DTSS 6134	160



Es Bağlantı
S Connection

kod code	ölçüler mm dimension mm
DTSS 6135	75
DTSS 6136	90
DTSS 6137	110

kod code	meme çapı mm nozzle dia. mm	basınç bar pressure bar	debi m ³ /s flow m ³ /h	çap m radius m	koli adet package pcs
DTSP - B6001	3,8 x 2,3	2,5	1.280	20	50
		3,5	1.680	24	50
DTSP - B6002	3,5 x 2,5	2,5	1.770	20	50
		3,5	2.110	24	50
DTSP - B6003	2,8 x 1,8	2,5	1.575	20	50
		3,5	1.975	24	50



Siyah S600 Sprink
Black S600 Sprinkler

kod code	meme çapı mm nozzle dia. mm	basınç bar pressure bar	debi m ³ /s flow m ³ /h	çap m radius m	koli adet package pcs
DTSP - B6011	3,8 x 2,3	2,5	1.280	20	50
		3,5	1.680	24	50
DTSP - B6012	3,5 x 2,5	2,5	1.770	20	50
		3,5	2.110	24	50
DTSP - B6013	2,8 x 1,8	2,5	1.575	20	50
		3,5	1.975	24	50



Siyah S601 Sprink
Black S601 Sprinkler

kod code	meme çapı mm nozzle dia. mm	basınç bar pressure bar	debi m ³ /s flow m ³ /h	çap m radius m	koli adet package pcs
DTSP - O6001	3,8 x 2,3	2,5	1.280	20	50
		3,5	1.680	24	50
DTSP - O6002	3,5 x 2,5	2,5	1.770	20	50
		3,5	2.110	24	50
DTSP - O6003	2,8 x 1,8	2,5	1.575	20	50
		3,5	1.975	24	50



Turuncu S600 Sprink
Orange S600 Sprinkler

kod code	meme çapı mm nozzle dia. mm	basınç bar pressure bar	debi m ³ /s flow m ³ /h	çap m radius m	koli adet package pcs
DTSP - B7001	3,8 x 0,0	2,5	1.620	22	50
		3,5	1.870	25	50
DTSP - B7002	4,2 x 0,0	2,5	2.110	22	50
		3,5	2.490	25	50



Siyah S700 Sprink
Black S700 Sprinkler

kod code	meme çapı mm nozzle dia. mm	basınç bar pressure bar	debi m ³ /s flow m ³ /h	çap m radius m	koli adet package pcs
DTSP - O8001	3,8 x 2,3	2,5	1.195	22	50
		3,5	1.430	25	50
DTSP - O8002	5,0 x 4,0	2,5	2.410	22	50
DTSP - O8003	4,2 x 3,5	3,5	2.895	25	50



Turuncu S800 Sprink
Orange S800 Sprinkler

kod code	meme çapı mm nozzle dia. mm	basınç bar pressure bar	debi m ³ /s flow m ³ /h	çap m radius m	koli adet package pcs
DTSP - G9001	3,8 x 2,3	2,5	1.620	20	50
		3,5	1.870	24	50
DTSP - G9002	4,2 x 3,5	2,5	1.200	20	50
		3,5	1.450	24	50
DTSP - G9003	5,0 x 4,0	2,5	2.110	20	50
		3,5	2.490	24	50



Gri S900 Sprink
Gray S900 Sprinkler

Mikro EK PARÇALAR Micro Fittings

Mikro Sprink Sistemleri
Micro Sprinkler Systems



Konuşulan Kalite

the spoken quality

www.arsulama.com



kod code	iç çap mm id mm	dış çap mm od mm	renk color
DTMPE 3x5	3	5	○●
DTMPE 4x6,5	4	6,5	○●
DTMPE 4x7	4	7	○●
DTMPE 12	9	12	○●



PE Spagetti Boru
Spaghetti PE Pipe



kod code	ölçüler mm dimension mm	debi lt/s flow rate lt/h	uzunluk length
DTM 1135	7	4	kısa/short
DTM 1128	5	2	uzun/long
DTM 1129	5	4	uzun/long

Saksı Kazığı
Hydroponic Stake

kod code	ölçüler mm dimension mm	paket adet package pcs
DTM 1130	5	1.000
DTM 1131	7	1.000



Hidroponik Dirsek
Hydroponic Elbow Connector

kod code	ölçüler mm dimension mm	paket adet package pcs
DTM 1132	5	1.000
DTM 1133	7	1.000



Hidroponik Dörtlü Dağıtıcı
Hydroponic Cross Connector

kod code	ölçüler mm dimension mm	paket adet package pcs
DTM 1134	5	1.000



Hidroponik İkili Dağıtıcı
Hydroponic Tee Connector

kod code	ölçüler mm dimension mm	paket adet package pcs
DTM 1101	4	1.000



Kör Tapa
End Cap

kod code	ölçüler mm dimension mm	paket adet package pcs
DTM 1102	7	1.000
DTM 1132	5	1.000



Start Çıkış
Start Nozzle

kod code	ölçüler mm dimension mm	paket adet package pcs
DTM 1103	7	1.000
DTM 1133	5	1.000



Nozul
Nozzle

kod code	ölçüler mm dimension mm	paket adet package pcs
DTM 1104	7	1.000



Ekleme
Nipple

kod code	uzunluk cm length cm	paket adet package pcs
DTM 1106	40	500
DTM 1107	75	200



Mini Sprink Kazığı
Stake

kod code	debi lt/s flow rate lt/h	atış çap m range m	renk color
DTM 1108	40	5	●
DTM 1109	70	7	●
DTM 1110	90	7,5	●
DTM 1111	105	8	●
DTM 1112	120	8	●
DTM 1113	140	8,5	●
DTM 1114	160	8,5	●
DTM 1115	200	9	●
DTM 1116	250	9	○
DTM 1117	300	9,5	●



Dönergeli Mini Sprink
Rotating Sprayer

kod code	debi lt/s flow rate lt/h	atış çap m range m	renk color
DTM 1118	40	3	●
DTM 1119	70	3,5	●
DTM 1120	90	3,5	●
DTM 1121	105	4	●
DTM 1122	120	4	●



Açılı Mini Sprink
Angled Sprayer

kod code	debi lt/s flow rate lt/h	renk color
DTM 1123	40	●
DTM 1124	70	●
DTM 1125	90	●



Sisleme Sprink
Mist Atomizer

kod code	açı (°) angle (°)	debi lt/s flow rate lt/h	atış çap m range m	paket adet package pcs
DTM 1126	180°	90	2,5	1.000
DTM 1127	360°	90	2,5	1.000



Mini Sprey Sisleme
Radius Stable Mini Sprayer





Galvaniz Ek Parçalar Plastik & Metal Filtreler

Galvanized Fittings Plastic & Metal Filters

Filtre Sistemleri
Filtration Systems

Konuşulan Kalite

the spoken quality

www.arsulama.com



Alıcı Hortum Rekoru - Anahtar Ağızlı
Coupling Hose Connection - Wrench Design

kod code	ölçüler mm dimension mm
DTIRF2001	1/2"
DTIRF2002	3/4"
DTIRF2003	1"
DTIRF2004	1 1/4"
DTIRF2005	1 1/2"
DTIRF2006	2"
DTIRF2007	2 1/2"
DTIRF2008	3"
DTIRF2009	4"
DTIRF2010	5"
DTIRF2011	6"



Direk Geçiş Hortum Rekoru
Coupling Hose Connection - Direct Pass

kod code	ölçüler mm dimension mm
DTIRF2012	1/2"
DTIRF2013	3/4"
DTIRF2014	1"
DTIRF2015	1 1/4"
DTIRF2016	1 1/2"
DTIRF2017	2"
DTIRF2018	2 1/2"
DTIRF2019	3"
DTIRF2020	4"



Redüksiyon Hortum Rekoru
Coupling Hose Reduction Connection

kod code	ölçüler mm dimension mm
DTIRF2021	1" x 3/4"
DTIRF2022	1 1/4" x 1"
DTIRF2023	1 1/2" x 1 1/4"
DTIRF2024	1 1/2" x 1"
DTIRF2025	2" x 1 1/4"
DTIRF2026	2" x 1 1/2"
DTIRF2027	2 1/2" x 2"
DTIRF2028	3" x 2 1/2"
DTIRF2029	3" x 2"



Galvaniz Hortum Eki
Hose Connector

kod code	ölçüler mm dimension mm
DTIRF2030	1/2"
DTIRF2031	3/4"
DTIRF2032	1"
DTIRF2033	1 1/4"
DTIRF2034	1 1/2"
DTIRF2035	2"
DTIRF2036	2 1/2"
DTIRF2037	3"
DTIRF2038	4"
DTIRF2039	5"
DTIRF2040	6"



Hortum Rekorlu Gübreleme Adaptörü
Hose Connection with Fertiliser Adapters

kod code	ölçüler mm dimension mm
DTIRF2041	1 1/2"
DTIRF2042	2"
DTIRF2043	2 1/2"
DTIRF2044	3"
DTIRF2045	4"



Gübreleme Adaptörü
Nipple with Fertiliser Adapters

kod code	ölçüler mm dimension mm
DTIRF2046	1 1/2"
DTIRF2047	2"
DTIRF2048	2 1/2"
DTIRF2049	3"
DTIRF2050	4"



Galvaniz Boru Nipel
Nipple

kod code	ölçüler mm dimension mm
DTIRF2051	1/2"
DTIRF2052	3/4"
DTIRF2053	1"
DTIRF2054	1 1/4"
DTIRF2055	1 1/2"
DTIRF2056	2"
DTIRF2057	2 1/2"
DTIRF2058	3"
DTIRF2059	4"
DTIRF2039	5"
DTIRF2040	6"



Galvaniz Manşon
Galvanized Manshon

kod code	ölçüler mm dimension mm
DTIRF2071	1/2"
DTIRF2072	3/4"
DTIRF2073	1"
DTIRF2074	1 1/4"
DTIRF2075	1 1/2"
DTIRF2076	2"
DTIRF2077	2 1/2"
DTIRF2078	3"
DTIRF2079	4"
DTIRF2080	5"
DTIRF2081	6"



Galvaniz Manşon Redüksiyon Diştan Yivli
Male Reduction Nipple

kod code	ölçüler mm dimension mm
DTIRF2082	1" x 3/4"
DTIRF2083	1 1/4" x 1"
DTIRF2084	1 1/2" x 1"
DTIRF2085	1 1/2" x 1 1/4"
DTIRF2086	2" x 1"
DTIRF2087	2" x 1 1/4"
DTIRF2088	2" x 1 1/2"
DTIRF2089	2 1/2" x 1 1/2"
DTIRF2090	2 1/2" x 2"
DTIRF2091	3" x 2 1/2"
DTIRF2092	3" x 2"
DTIRF2093	4" x 2 1/2"
DTIRF2094	4" x 3"



Galvaniz Manşon Redüksiyon İçten Yivli
Female Reduction Nipple

kod code	ölçüler mm dimension mm
DTIRF2095	2" x 1"
DTIRF2096	2" x 1 1/4"
DTIRF2097	2" x 1 1/2"
DTIRF2098	2 1/2" x 1 1/2"
DTIRF2099	2 1/2" x 2"
DTIRF2100	3" x 2 1/2"
DTIRF2101	3" x 2"
DTIRF2102	4" x 2 1/2"
DTIRF2103	4" x 3"
DTIRF2039	5"
DTIRF2040	6"



Galvaniz Redüksiyon - İçten Dışa
Female - Male Reduction Nipple

kod code	ölçüler mm dimension mm
DTIRF2104	2" x 1"
DTIRF2105	2" x 1 1/4"
DTIRF2106	2" x 1 1/2"
DTIRF2107	2 1/2" x 1 1/2"
DTIRF2108	2 1/2" x 2"
DTIRF2109	3" x 2 1/2"
DTIRF2110	3" x 2"
DTIRF2111	4" x 2 1/2"
DTIRF2112	4" x 3"
DTIRF2039	5"
DTIRF2040	6"



Galvaniz Redüksiyon - Diştan İç
Male - Female Reduction Nipple

kod code	ölçüler mm dimension mm
DTIRF2113	2" x 1"
DTIRF2114	2" x 1 1/4"
DTIRF2115	2" x 1 1/2"
DTIRF2116	2 1/2" x 1 1/2"
DTIRF2117	2 1/2" x 2"
DTIRF2118	3" x 2 1/2"
DTIRF2119	3" x 2"
DTIRF2120	4" x 2 1/2"
DTIRF2121	4" x 3"
DTIRF2039	5"
DTIRF2040	6"

kod code	ölçüler mm dimension mm
DTIRF2122	1"
DTIRF2123	1 1/4"
DTIRF2124	1 1/2"
DTIRF2125	2"
DTIRF2126	2 1/2"
DTIRF2127	3"
DTIRF2128	4"
DTIRF2129	5"
DTIRF2130	6"



Galvaniz Deve Boynu
Male - Female Elbow

kod code	ölçüler mm dimension mm
DTIRF2131	1"
DTIRF2132	1 1/4"
DTIRF2133	1 1/2"
DTIRF2134	2"
DTIRF2135	2 1/2"
DTIRF2136	3"
DTIRF2137	4"
DTIRF2138	5"
DTIRF2139	6"



Galvaniz Deve Boynu - Çıkış Adaptörlü
Male - Female Elbow with Adapters

kod code	ölçüler mm dimension mm
DTIRF2140	1"
DTIRF2141	1 1/4"
DTIRF2142	1 1/2"
DTIRF2143	2"
DTIRF2144	2 1/2"
DTIRF2145	3"
DTIRF2146	4"

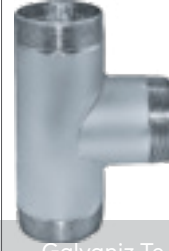

Galvaniz Te
Galvanized Tee

kod code	ölçüler mm dimension mm
DTIRF2147	1"
DTIRF2148	1 1/4"
DTIRF2149	1 1/2"
DTIRF2150	2"
DTIRF2151	2 1/2"
DTIRF2152	3"
DTIRF2153	4"

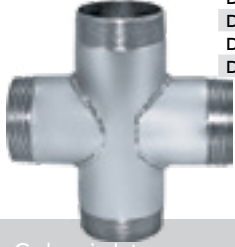

Galvaniz İstavroz
Galvanized Cross

kod code	ölçüler mm dimension mm
DTIRF2154	1"
DTIRF2155	1 1/4"
DTIRF2156	1 1/2"
DTIRF2157	2"
DTIRF2158	2 1/2"
DTIRF2159	3"
DTIRF2160	4"



Galvaniz Manşonlu Te
Galvanized Tee with Manshon

kod code	ölçüler mm dimension mm
DTIRF2173	2"
DTIRF2174	2 1/2"
DTIRF2175	3"
DTIRF2176	4"



Boru Ye Bağlantı
Y Connection

kod code	ölçüler mm dimension mm
DTIRF2177	2 Way Out
DTIRF2178	3 Way Out



Jet Gübreleme Kollektörü
Jet Fertilization Collector

kod code	ölçüler mm dimension mm
DTIRF2168	1 1/2"
DTIRF2169	2"
DTIRF2170	2 1/2"
DTIRF2171	3"
DTIRF2172	4"



Gübreleme Kollektörü
Fertilization Collector

kod code	ölçüler mm dimension mm
DTIRF2179	1/2" (10 cm ... 100 cm)
DTIRF2180	3/4" (10 cm ... 100 cm)
DTIRF2181	1" (10 cm ... 100 cm)
DTIRF2182	1 1/4" (10 cm ... 100 cm)
DTIRF2183	1 1/2" (10 cm ... 100 cm)
DTIRF2184	2" (10 cm ... 100 cm)
DTIRF2185	2 1/2" (10 cm ... 100 cm)
DTIRF2186	3" (10 cm ... 100 cm)
DTIRF2187	4" (10 cm ... 100 cm)



Galvaniz Boru Uzatma Parçası
Galvanized Pipe Extension

kod code	ölçüler mm dimension mm
DTIRF2271	1"
DTIRF2272	1 1/4"
DTIRF2273	1 1/2"
DTIRF2274	2"
DTIRF2275	2 1/2"
DTIRF2276	3"
DTIRF2277	4"
DTIRF2278	5"
DTIRF2279	6"



Patent Dirsek
Patent Elbow

kod code	ölçüler mm dimension mm
DTIRF2260	1/2"
DTIRF2261	3/4"
DTIRF2262	1"
DTIRF2263	1 1/4"
DTIRF2264	1 1/2"
DTIRF2265	2"
DTIRF2266	2 1/2"
DTIRF2267	3"
DTIRF2268	4"
DTIRF2269	5"
DTIRF2270	6"



Kaynatma Boru Ucu
Galvanized Pipe Tip



kod code	ölçüler mm dimension mm
DTMP1749	2"
DTMP1750	2 1/2"
DTMP1751	3"
DTMP1752	4"
DTMP1753	5"
DTMP1754	5 1/2"
DTMP1755	6"

Alüminyum Dişi Motopomp
Latch Type Female Motopomp Connection - Aluminium



kod code	ölçüler mm dimension mm
DTMP1756	2"
DTMP1757	2 1/2"
DTMP1758	3"
DTMP1759	4"
DTMP1760	5"
DTMP1761	5 1/2"
DTMP1762	6"

Alüminyum Mandallı Erkek Motopomp
Latch Type Male Motopomp Connection - Aluminium



kod code	ölçüler mm dimension mm
DTMP1766	2 1/2"
DTMP1767	3"
DTMP1768	4"

Polyamid Gövdeli Dişi Motopomp
Latch Type Female Motopomp Connection - Polyamide



kod code	ölçüler mm dimension mm
DTMP1763	2 1/2"
DTMP1764	3"
DTMP1765	4"

Polyamid Gövdeli Erkek Motopomp
Latch Type Male Motopomp Connection - Polyamide



kod code	ölçüler mm dimension mm
DTBV1827	2"
DTBV1828	2 1/2"
DTBV1829	3"
DTBV1830	4"
DTBV1831	5"
DTBV1832	6"

Polyamid Gövdeli Kelebek Vana
Butterfly Valve - Polyamide



kod code	ölçüler mm dimension mm
DTBV1833	2"
DTBV1834	2 1/2"
DTBV1835	3"
DTBV1836	4"
DTBV1837	5"

Polyamid Gövdeli İçten Dişli Kelebek Vana
Butterfly Female Valve - Polyamide



kod code	ölçüler mm dimension mm
DTBV1838	2"
DTBV1839	2 1/2"
DTBV1840	3"
DTBV1841	4"
DTBV1842	5"

Polyamid Gövdeli İçten Dişli 4 Yollu Gübreleme Vanası
Butterfly Female Valve - 4 Way Out - Polyamide



Plastik Mini Filtre
Plastic Mini Filter

kod code	giriş - çıkış inch in - out inch	kartuş tipi cartridge type
DFE-100	1"	Mech
DFE-114	1 1/4"	Mech
DFE-112	1 1/2"	Mech
DFE-200	2"	Mech
DFD-100	1"	Disc
DFD-114	1 1/4"	Disc
DFD-112	1 1/2"	Disc
DFD-200	2"	Disc



Plastik Tekli Filtre
Plastic Single Filter

kod code	giriş - çıkış inch in - out inch	filtreleme alanı cm ² tank type cm ²	debi m ³ /s (mak.) flow rate m ³ /h (max.)
DF-PKD-20	2"	Disc-1200	20
DF-PKDS-20	2"	Disc-1700	30
DF-PKD-25	2 1/2"	Disc-1200	30
DF-PKDS-25	2 1/2"	Disc-1700	35
DF-PKD-30	3"	Disc-1200	40
DF-PKDS-30	3"	Disc-1700	45
DF-PKE-20	2"	Mech-750	20
DF-PKES-20	2"	Mech-1000	30
DF-PKE-25	2 1/2"	Mech-750	30
DF-PKES-25	2 1/2"	Mech-1000	35
DF-PKE-30	3"	Mech-750	40
DF-PKES-30	3"	Mech-1000	45



kod code	giriş - çıkış inch in - out inch	filtreleme alanı cm ² tank type cm ²	debi m ³ /s (mak.) flow rate m ³ /h (max.)
DF-PXD-30	3"	Disc-2400	50
DF-PXDS-30	3"	Disc-3400	60
DF-PXD-40	4"	Disc-2400	70
DF-PXDS-40	4"	Disc-3400	80
DF-PXE-30	3"	Mech-1500	50
DF-PXES-30	3"	Mech-2000	60
DF-PXE-40	4"	Mech-1500	70
DF-PXES-40	4"	Mech-2000	80





Plastik İkiz Filtre
Plastic Double Filter





Ayaklı Filtre
Filter Stand

kod code	bağlantı çapı cm connection dia. cm	ölçü cm dimensions cm	boy cm height cm	kapasite ton/s capacity tonne/h	filtre filter
DF-AFD 2025	2"	22	25	20-22	disk 
DF-AFD 2040		22	40	20-22	
DF-AFD 2535	2 1/2"	22	35	27-35	
DF-AFD 2550		22	50	27-35	
DF-AFD 3040	3"	22	40	43-57	
DF-AFD 3050		22	50	43-57	
DF-AFD 4050	4"	22	50	55-70	
DF-AFD 4070		22	70	55-70	

kod code	bağlantı çapı cm connection dia. cm	ölçü cm dimensions cm	boy cm height cm	kapasite ton/s capacity tonne/h	filtre filter
DF-AFM 2025	2"	22	25	20-22	mech 
DF-AFM 2040		22	40	20-22	
DF-AFM 2535	2 1/2"	22	35	27-35	
DF-AFM 2550		22	50	27-35	
DF-AFM 3040	3"	22	40	43-57	
DF-AFM 3050		22	50	43-57	
DF-AFM 4050	4"	22	50	55-70	
DF-AFM 4070		22	70	55-70	

disk

mech



Kum için Hidrosiklon
Hydrocyclone for Sand

kod code	bağlantı çapı cm connection dia. cm	kapasite ton/s capacity tonne/h
DF-HYC 20	2"	20-22
DF-HYC 25	2 1/2"	27-35
DF-HYC 30	3"	43-57
DF-HYC 40	4"	55-70



Seperator Tip Hidrosiklon
Separator Type Hydrocyclone

kod code	bağlantı çapı cm connection dia. cm	kapasite ton/s capacity tonne/h
DF-SEP 20	2"	18-22
DF-SEP 25	2 1/2"	24-35
DF-SEP 30	3"	40-57
DF-SEP 40	4"	50-70
DF-SEP 50	5"	80-110
DF-SEP 60	6"	110-140

kod code	tank tipi tank type	kapasite lt capacity lt
DF-GV 50	dikey / vertical	50
DF-GV 100	dikey / vertical	100
DF-GH 100	yatay / horizontal	100
DF-GH 200	yatay / horizontal	200
DF-GH 350	yatay / horizontal	350



Gübre Tankı
Fertilizer Tank

kod code	giriş-çıkış inç in-out inch	filtre miktarı ve çapı cm filter quantity and diameter cm	disk filtre miktarı ve kodu disk filter quantity and it's code	debi m ³ /s (min-maks) flow rate m ³ /h (min-max)
DF-YHPO-462	4"/ Manshon	2 ad/pcs 3"(14")	2 ad/pcs DF-PKDS-30	50-80
DF-YHPO-592	5"/ Flange	2 ad/pcs 4"(36")	2 ad/pcs DF-PXD-40	80-90
DF-YHPO-563	5"/ Flange	3 ad/pcs 3"(24")	3 ad/pcs DF-PKDS-30	95-110
DF-YHPO-663	6"/ Flange	3 ad/pcs 3"(24")	3 ad/pcs DF-PKDS-30	100-120
DF-YHPO-593	5"/ Flange	3 ad/pcs 4"(36")	3 ad/pcs DF-PXD-40	105-130
DF-YHPO-693	6"/ Flange	3 ad/pcs 4"(36")	3 ad/pcs DF-PXD-40	120-140
DF-YHPO-664	6"/ Flange	4 ad/pcs 3"(25")	4 ad/pcs DF-PKDS-30	130-160
DF-YHPO-694	6"/ Flange	4 ad/pcs 4"(36")	4 ad/pcs DF-PXD-40	140-185
DF-YHPO-895	8"/ Flange	5 ad/pcs 4"(36")	5 ad/pcs DF-PXD-40	190-280



Tam Otomatik / Hidrosiklon ve Plastik Filtreli Yosun Sistemi
Fully Automatic / Hydrocyclone and Gravel System with Plastic Disc Filter

kod code	giriş-çıkış inç in-out inch	filtre miktarı ve çapı cm filter quantity and diameter cm	disk filtre miktarı ve kodu disk filter quantity and it's code	debi m ³ /s (min-maks) flow rate m ³ /h (min-max)
DF-YKPO-462	4"/ Manshon	2 ad/pcs 3"(24")	2 ad/pcs DF-PKDS-30	40-80
DF-YKPO-592	5"/ Flange	2 ad/pcs 4"(36")	2 ad/pcs DF-PXD-40	70-90
DF-YKPO-692	6"/ Flange	2 ad/pcs 4"(36")	2 ad/pcs DF-PXD-40	70-100
DF-YKPO-563	5"/ Flange	3 ad/pcs 3"(24")	3 ad/pcs DF-PKDS-30	70-110
DF-YKPO-663	6"/ Flange	3 ad/pcs 3"(24")	3 ad/pcs DF-PKDS-30	70-120
DF-YKPO-593	5"/ Flange	3 ad/pcs 4"(36")	3 ad/pcs DF-PXD-40	105-130
DF-YKPO-693	6"/ Flange	3 ad/pcs 4"(36")	3 ad/pcs DF-PXD-40	105-140
DF-YKPO-664	6"/ Flange	4 ad/pcs 3"(24")	4 ad/pcs DF-PKDS-30	120-160
DF-YKPO-694	6"/ Flange	4 ad/pcs 4"(36")	4 ad/pcs DF-PXD-40	140-185
DF-YKPO-895	8"/ Flange	5 ad/pcs 4"(36")	5 ad/pcs DF-PXD-40	175-280



Tam Otomatik / Plastik Filtreli Yosun Sistemi
Fully Automatic / Gravel System with Plastic Disc Filter



Kollektör Sistemi
Collecting Unit



Kollektör Sistemi
Collecting Unit

Sulama sistemlerinde suyun partiküllerden uzaklaştırılma işlemine filtrasyon denilmektedir. Sulama sistemlerinde kullanıldığımız sprinklerin ve damlatıcıların tıkanması en büyük problemlerden biridir. Filtrasyon, sulama sisteminde kullanılan damlatıcı, sprink, vana v.b ekipmanlara partiküllerin girmesini engellemek için en iyi koruma yöntemidir. Çünkü tıkanan bir damlatıcıyı bulmak zahmetli bir iştir. Bu yüzden filtrasyon, bir sulama sisteminin en önemli birimini oluşturur.

Filtre seçiminde dikkat edilmesi gereken bazı parametreler vardır.

- Maksimum ve minimum su basıncı
- Su kaynağı ve kirlilik türü
- Gerekli su akışı (*kapasite*)
- Gerekli su kalitesi
- Gerekli filtrasyon (mikron değeri)
- Ön filtreleme gereksinimi
- Gelecekteki ihtiyaçlar

Bu bilgiler dahilinde imalatımızda size en uygun filtreyi üretiyoruz. İlerki sayfalarda bazı hazır modellerimizden ürün seçebilirsiniz.

Sizlere verimli bir sulama sağlamak için çok çeşitli disk, hidrosiklon / kum ayırıcı, gravel ve elek filtreleri sunuyoruz.

Proje ekibimizden geçen her AR filtresi, dayanıklı yapısı ve mükemmel filtreleme performansı ile en yüksek seviyede koruma sağlamak üzere üretilmiştir.

Kolay kapasite genişletme özelliği ile, tak ve çalıştır kurulum için modüler olarak tasarlanmış filtreleme ünitesi.

Otomatik kontrollü disk filtre, gravel filtrasyonunun etkinliğini ve elek filtrelerinin verimliliğini tek bir filtrede birleştirir.

Olağanüstü dizaynı 3 boyutlu filtreleme, en iyi seviyede organik madde giderimi sağlar. Sistemlerimize eklediğimiz Hızlı ve verimli bir ters yıkama, girdi maliyetlerinden tasarruf etmenize yardımcı olur.

Kontrol panelleri, ters yıkama valfleri ve sehpa ile birlikte komple önceden monte edilmiş üniteler mevcuttur.

The process of removing water from particles in irrigation systems is called filtration. Clogging of sprinklers and drippers that we use in irrigation systems is one of the biggest problems. Filtration is the best protection method to prevent particles from entering the dripper, sprinkler, valve, etc. equipment used in the irrigation system. Because finding a clogged dripper is a painstaking task. Therefore, filtration forms the most important unit of an irrigation system.

There are some parameters to be considered in filter selection.

- Maximum and minimum water pressure
- Water source and pollution type
- Required water flow (*capacity*)
- Required water quality
- Required filtration (micron value)
- Pre-filtration requirement
- Future needs

with this information, we produce the most suitable filter for you in our production. On the following pages, you can choose products from some of our ready-made models.

We offer a wide range of disc, hydrocyclone / sand separator, gravel and screen filters to provide you with efficient irrigation.

Every AR filter that passes through our project team is manufactured to provide the highest level of protection with its durable structure and excellent filtering performance.

Modular designed filtration unit for plug and play installation, with easy capacity expansion.

The automatic controlled disc filter combines the efficiency of gravel filtration and the efficiency of screen filters in a single filter.

The exceptionally designed 3D filtration provides the best organic matter removal. A fast and efficient backwash we add to our systems helps you save on input costs.

Complete pre-assembled units are available with control panels, backwash valves and stand.



AR TARIMSAL SULAMA EKİPMANLARI

Konya Fabrika - Konya Factory

📍 Fevziçakmak Mh. 10726. Sk. No:35 42050, Karatay/KONYA/TÜRKİYE

☎ +90 332 345 14 51 📠 +90 332 345 14 52 ✉ bilgi@arsulama.com

Genel Müdürlük ve Depo - Head Office and Warehouse

📍 Fevziçakmak Mh. Sıla Cad. No: 48B 42050, Karatay/KONYA/TÜRKİYE

☎ +90 332 345 14 51 📞 +90 555 530 00 53 ✉ info@driptime.com.tr
Export Dep. WhatsApp Mobile Line



www.arsulama.com



www.driptime.com.tr